



Barcode: 5060452084985

Patent: 2211899.6

siteboss™ piano box

Product code: SB49

- » Ultra secure jobsite piano box for your tools.
- » Organization made simple with multi-purpose tool shelf.
- » Features the extreme UltraLock security system.



Product features



UltraLock



Gas strut (1000N)

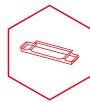

Multi-purpose tool shelf



4 way fork pockets



Suitable for jobsite



Power cable pass-through



Built in handles

Product specifications

Weight	420lbs
Color	Black grey: RAL 7021, Traffic red: RAL 3020
Suitable for	Jobsite
Finished coating	Powder coated
Material	14 gauge steel
Suitable for vehicle mounting	No
How are casters fitted?	Quick-fix caster plates
Other sizes available	4 other sizes
Assembly required?	Yes
Qty of shelves as standard	1 fixed shelf, 1 tool caddy

Dimensions - External dimensions includes protrusions

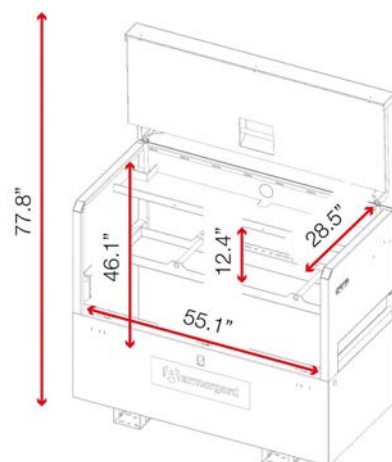
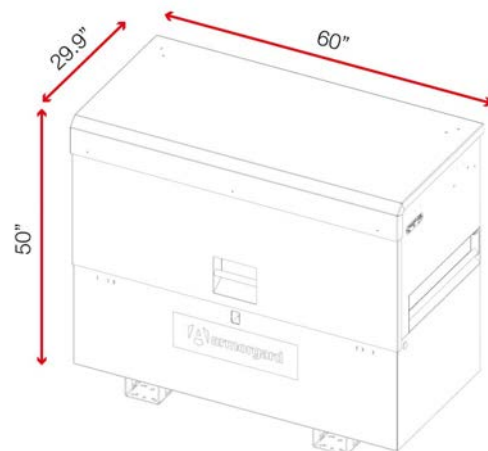

Optional extras - Contact Armorgard to find out more



Lifting eye kit CLEK4



HD Caster kit

Related products



SiteBoss Cabinet SB48



Forma-Stor FR200-TT

Disclaimer: all dimensions and weights are approximate